

ШКАФ НАВЕСНОЙ С НАПОЛНЕНИЕМ

КОМФОРТ

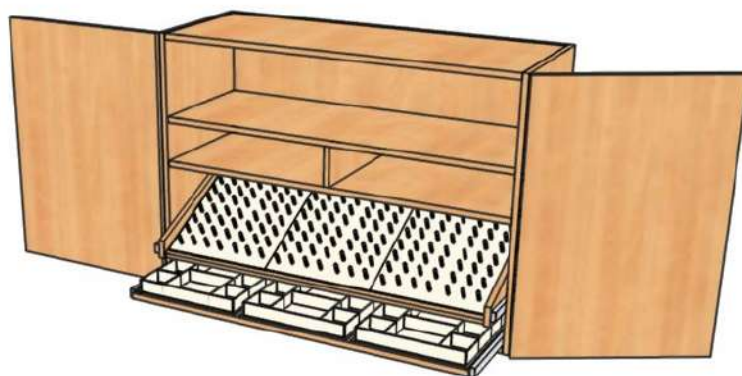

SYMBOLS

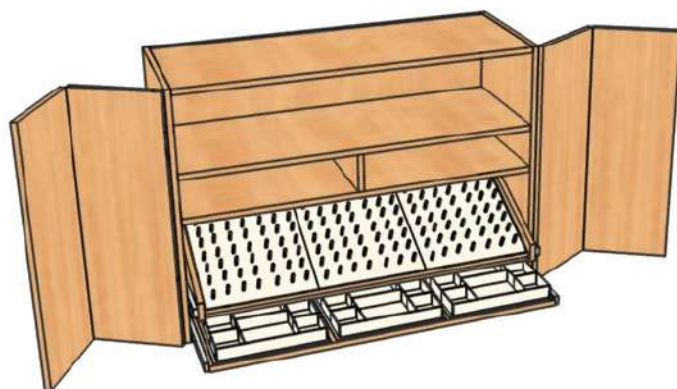

ATTENTION

ВНИМАНИЕ



ASSEMBLY & ADJUSTMENT

СБОРКА РЕГУЛИРОВКА

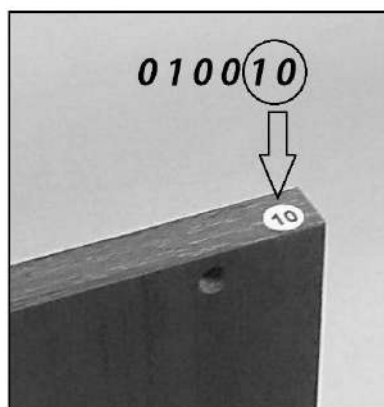

INDICATING MARK

ОБОЗНАЧЕНИЕ

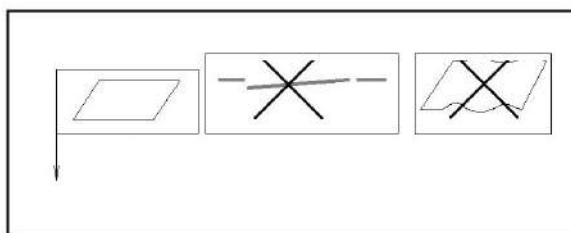















EVEN SURFACE

РОВНАЯ ПОВЕРХНОСТЬ

010001	1 x	010003	1 x	010004	1 x
010006	1 x	010007	1 x	010008	1 x
010015	1 x	010025	1 x	010026	1 x
010027	1 x	010028	1 x	010031	1 x
010033	2x	010034	1 x		

 <p>020004 2x 020005 2x</p>	 <p>2x 020006</p>	 <p>4x 020018</p>	 <p>4 x 020019</p>	 <p>2x 020020</p>
 <p>4x 020051 C L350</p>	 <p>2x 020070</p>	 <p>1 x 020071</p>		
 <p>4x 020051 D L350</p>		 <p>1 M</p>		

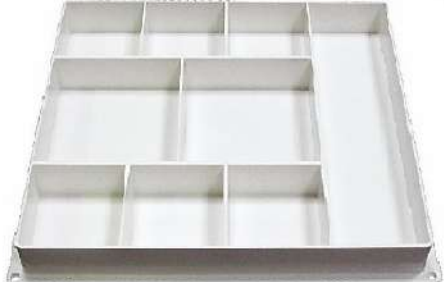
 <p>030001 4x 3 * 16</p>	 <p>030002 56x 3,5 * 16</p>	 <p>26x 030003 6,2 * 50</p>	 <p>030006 4x 2,9 * 13</p>	 <p>030009 4x M4 * 20</p>	 <p>030008 4x φ 4</p>	 <p>030011 26x φ 15</p>
 <p>030028 4x 3,5 * 30</p>	 <p>030033 16x 4,2 * 13</p>	 <p>2x 030036 4 * 40</p>	 <p>2x 030037</p>			

 <p>3x 050004</p>	 <p>3x 050005</p>	<p>S4</p>  <p>1x</p>
--	---	---

4 **3x 050004**



12x 030002 

010034

2x 020020



2

010025

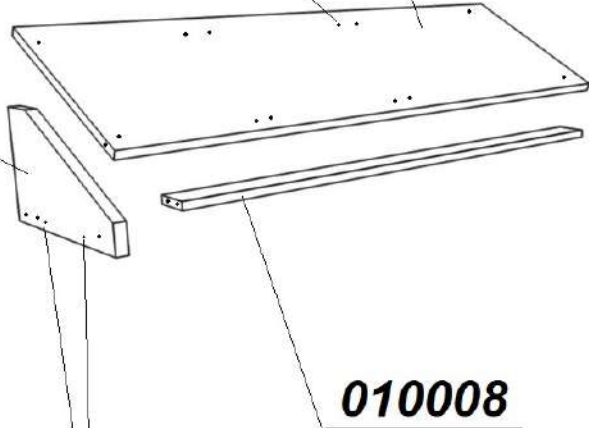

010027

6x  **030011** **1**

6x  **030003**

3 **2x 020051 D** **4x**  **030002**





6 **3x 050005**

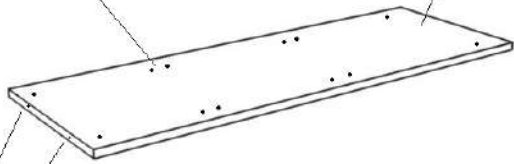

12x 030002 

010028





5 **2x 020051 D** **4x**  **030002**

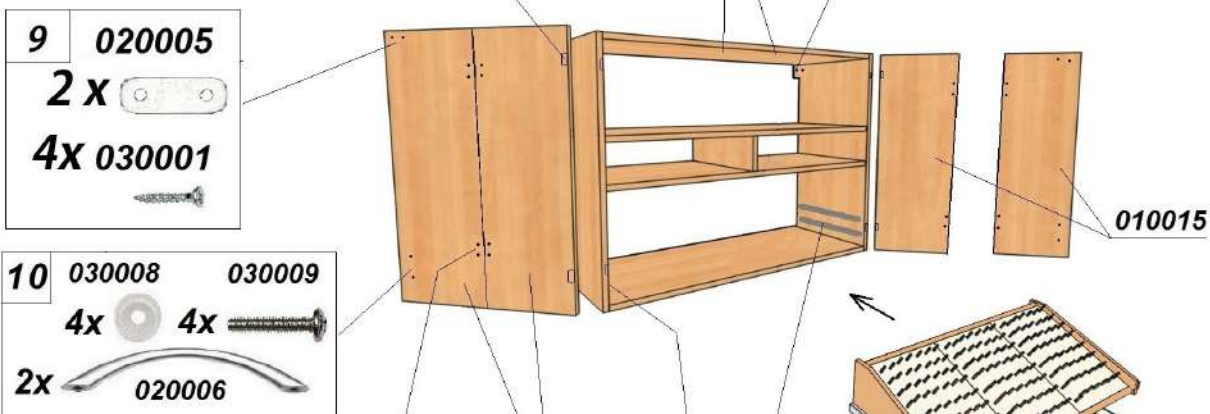
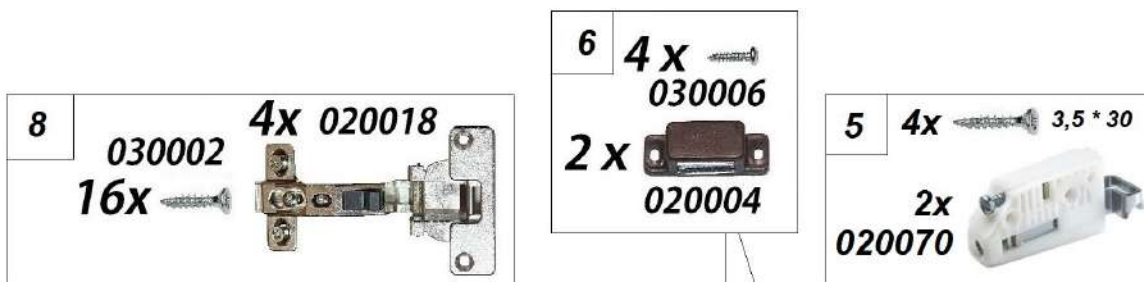
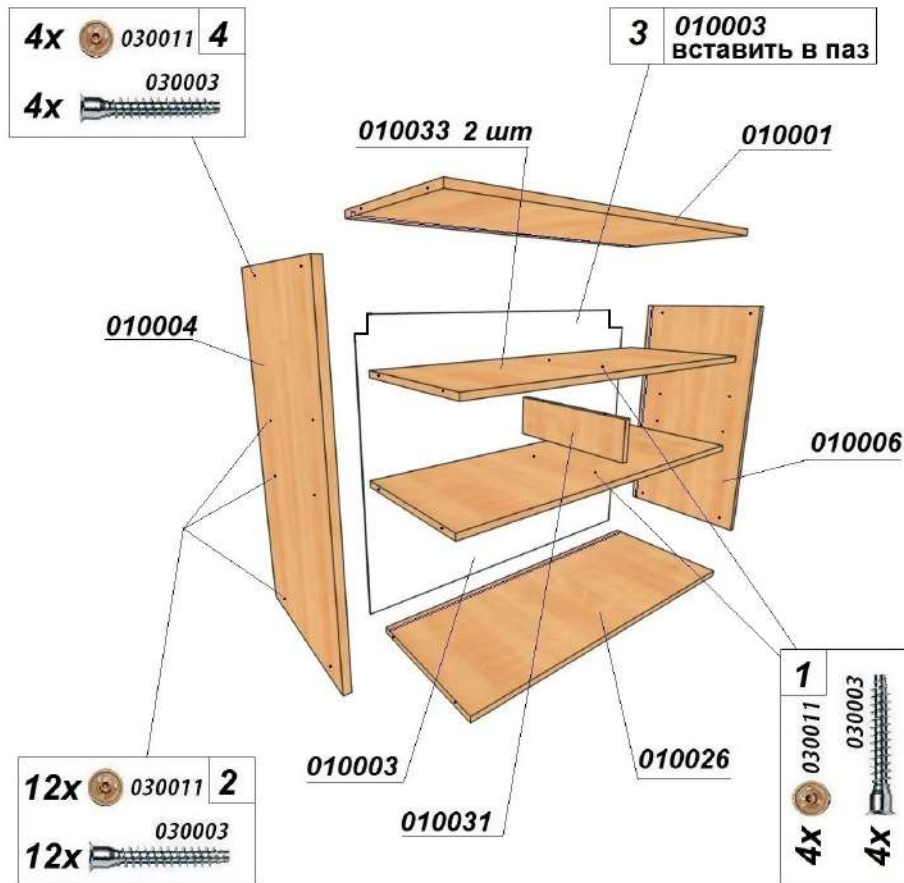

4



- 2x 030036 
- 2x 030037 

1x 020071

